



CYBERBOARD R4 用户使用手册

CYBERBOARD R4 User Manual

感谢选购

Thank you for your purchase



目 录

01	产品说明	03
02	包装清单	07
03	快速入门向导	09
04	快捷键	11
05	键位及灯效自定义	16
06	拆装说明	19
07	Leaf Spring 手感配置	21
08	安全须知	23
09	防伪须知	26
10	售后服务	28

01 产品说明

产品说明

产品名称	CYBERBOARD
重量	2.65(±0.1) kg, 不含轴与键帽 / 2.9 (±0.1) kg, 含轴与键帽
人机角度	10°
LED 数量	5*40 动态点阵, 200 颗 LED 屏幕灯珠, 81 轴底灯
结构	三段式可调节 Leaf Spring
驱动	自驱, 全键无冲
键位 / 灯效自定义	Windows / Mac OS 可自定义
轴固定方式	热插拔
连接方式	蓝牙 (Win 系统需 Windows 8.0 以上)、有线 (USB 有线连接自动切换)
Caps Lock 提示灯	提示灯位于数字 6 与 7 之间
USB 接口	USB 2.0, TypeC, 支持 C to C
电池	锂聚合物 5000mAh *2, 共 10000mAh (典型值)
Qi 无线充电	充电功率 5W, 电池电量低于 85% 开启, 直到 100% 时停止
LED 颜色	256 色
整机最大功耗	8W

产品说明

成品套装

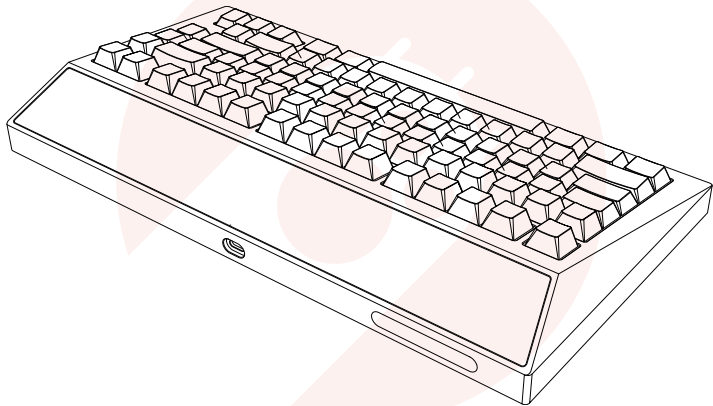

产品说明

套件

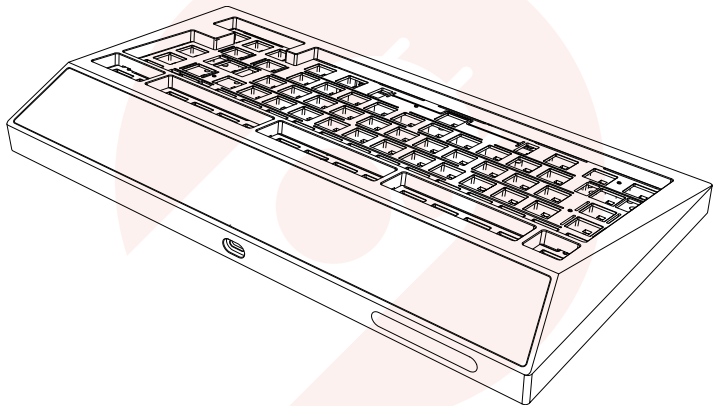

02 包装清单

2. 包装清单

套件包含：

键盘外壳（铝合金材质）；PCB（热插拔，开槽，RGB，厚度 1.2mm）；POM 定位板（开槽）；Leaf Spring 手感调节工具包；军火箱

套装包含：

除含套件里的所有配件外，还含有：

键帽 81 颗 *；冰银轴 Pro 81 颗（线性）；佳达隆 INK 黑卫星轴 4 组（螺丝式，2U*3，6.25U*1）

* 云白 V2 成品套装，默认装配怒喵 021C 键帽，其它颜色的成品套装，则默认装配黑透版的冰川透明键帽

03 快速入门向导

快速入门向导

1. 将 CYBERBOARD R4 从包装中取出
2. 第一次使用需 USB 数据线连接设备以激活
3. 开 / 关机：长按 Fn + Esc
4. 蓝牙配对：（非插线状态）长按 Fn + 1，至 LED 屏幕图标  进入蓝牙配对状态
5. 电量显示：短按 Fn + F12，LED 屏幕灯效切换到最后一个，为电量显示

04 快捷键

快捷键示意

1、开关机

长按 Fn + Esc 3 秒

2、恢复出厂设置

Fn + R 长按 5 秒

3、多媒体组合键

Fn + F1

静音

Fn + F2

减小音量

Fn + F3

增大音量

Fn + F4

上一首

Fn + F5

下一首

Fn + F6

播放 / 暂停

快捷键示意

4、LED 屏幕 / 轴底灯效组合键

Fn + F9	开启 / 关闭 轴底灯效
Fn + F10	开启 / 关闭 屏幕灯效
Fn+F11	轴底灯效切换
Fn+F12	切换屏幕灯效，最后一个灯效为电量显示
Fn + ↑	提升屏幕亮度
Fn + ↓	降低屏幕亮度
Fn + →	提升屏幕灯效速度
Fn + ←	降低屏幕灯效速度
Fn + -/+	降低 / 增加轴底灯亮度

快捷键示意

5、蓝牙连接

Fn + 1	蓝牙模式下连接设备 1，长按直到 LED 屏幕图标 闪烁，配对成功后停止闪烁，屏幕恢复之前的显示模式
Fn + 2	蓝牙模式下连接设备 2，长按直到 LED 屏幕图标 闪烁，配对成功后停止闪烁，屏幕恢复之前的显示模式
Fn + 3	蓝牙模式下连接设备 3，长按直到 LED 屏幕图标 闪烁，配对成功后停止闪烁，屏幕恢复之前的显示模式
设备切换	按 Fn+1/2/3 可在不同设备间切换，图标提示 5 秒后，LED 恢复之前的显示模式
蓝牙模式待机状态	待机 10 分钟后，LED 自动熄屏，蓝牙不断开。按键自动唤醒 * 有线模式默认不待机，但如果连接的电脑关机，键盘则会自动进入蓝牙模式，并在 10 分钟后待机

快捷键示意

6、电量显示

电量提示

FN + F12, 屏幕灯效切换到最后一个, 为电量显示



充电开启

充电开启后, 短暂提示充电动画 3 秒, 然后恢复到之前的屏幕灯效



充电提示

充电时, 按 FN + F12, 屏幕灯效切换到最后一个, 出现电量图标和呼吸状态的 "+" 号图标



充满提示

右侧图标常亮 5 秒, 之后恢复为之前的屏幕灯效



低电量提示

当电量低于 5% 时, 强制红色电量提示, 直到电量耗尽。
可按 FN+F10 熄屏



05 键位及灯效自定义

键位及灯效自定义

1. 于 angrymiao.com/am-master/ 下载 AM Master，期间保持键盘通过 USB 连接到电脑
 2. 进入 diy.angrymiao.com，顶部标签栏选择键盘型号，开始编辑键位与灯效（灯效编辑，需点击 diy 页面右下角进入）
 3. 完成编辑后，生成 json 文件并下载到本地
 4. 打开 AM Master，选择下载的 json 文件导入（可直接使用他人分享的配置文件）
 5. 等待一会，至配置生效
- 键位分层：默认可通过按住 Fn 键，进入第 2 层。或通过短按自定义 Layer 键，直接切换至设定的对应层，最多可支持 7 层

CYBERBOARD 灯效教程

DIY 页面 diy.angrymiao.com

灯效编辑视频教程见页面底部入口

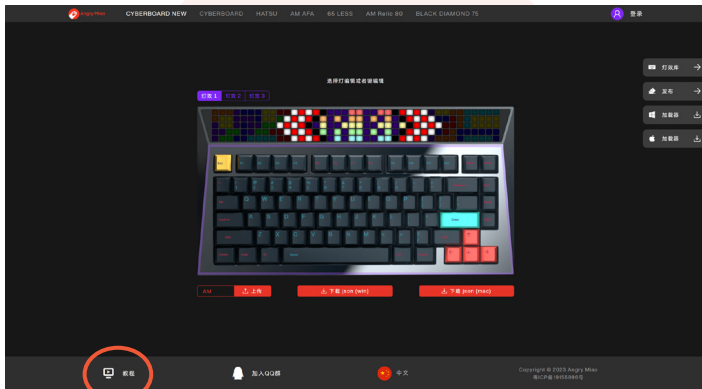

06 拆装说明

拆装说明

热插拔 PCB 换轴提示：

请按拆装说明谨慎断开排线，取出内胆，以温和力度安装轴体

安装时，请确保轴脚为正常垂直状态，并无弯曲。如遇到无法插入的情况，请调整轴体角度、观察轴脚并无异常情况。切忌用力过度，可能会导致轴座甚至 PCB 主板损坏

扫码观看键盘拆装教程

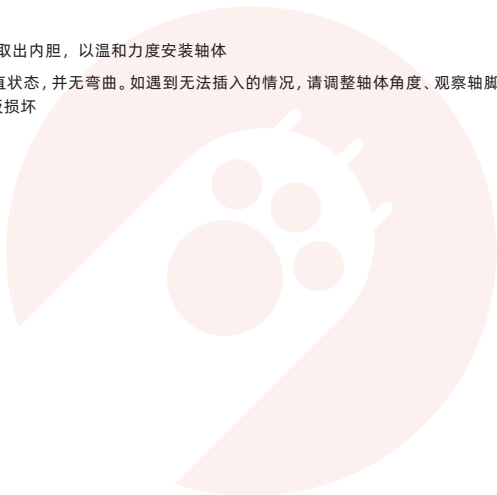

07 Leaf Spring 手感配置

Leaf Spring 手感配置

		不锈钢弹片 (偏硬, 默认配置) * 可替换为 磷铜弹片 (偏软)		
	一档 (软弹) (无胶塞)			
	二档 (适中) (仅二档处放胶塞)		默认配置	
	三档 (硬) (仅三档处放胶塞)			
PCB 背贴垫		1 (默认贴上, 可撕)		
调整垫 (镂空)	无调整垫 (较软)	1张调整垫 (适中, 默认垫上)	2张调整垫 (较硬)	
底垫 (不镂空)	1 (减少空腔音, 保护 PCB 元器件; 默认垫上)			

08 安全须知

产品有害物质名称及含量

部件名称	有害物质					
	铅 (Pb)	汞 (Hg)	镉 (Cd)	六价铬 (Cr(VI))	多溴联苯 (PBB)	多溴二苯醚 (PBDE)
印刷电路板	X	O	O	O	O	O
金属零件	O	O	O	O	O	O
塑胶零件	O	O	O	O	O	O
电池	X	O	O	O	O	O
配件	X	O	O	O	O	O

本表格依据 SJ/T 11364 的规定编制
O: 表示该有害物质在该部件所有均质材料中的含量均在 GB/T 26572 规定的限量要求以下
X: 表示该有害物质至少在该部件的某一均质材料中的含量超出 GB/T 26572 规定的限量要求, 且目前业界没有成熟的替代方案。请妥善处理此类部件或物质, 以免对环境 and 人体健康造成影响



根据中国电子行业标准 SJ/T 11364-2014 和相关的中国政府法规, 本产品及其某些内部或外部组件上可能带有环保使用期标识。取决于组件和组件制造商, 产品及其组件上的使用期限标识可能有所不同。组件上的使用期限标识优于产品上任何与之冲突的或不同的环保使用期限标识

警告

- 禁止拆解、撞击、挤压或投入火中
- 若出现严重鼓胀请勿继续使用
- 请勿置于高温环境中
- 电池浸水后禁止使用
- 如果电池更换不当会有爆炸危险，仅限合格的维修人员使用相同的备件执行维修操作。这可确保维持产品的安全性

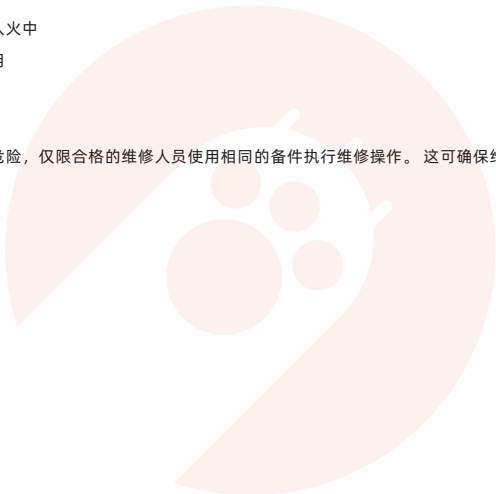

09 防伪须知

防伪须知

防伪声明:

为了保障您的权益及购物体验,请在产品到货后,第一时间进行防伪查询。每个SN码都是唯一的,且仅可以验证对应的一件商品。若无法查询到对应的SN码,请您仔细辨别该产品

Angry Miao 致力于为用户提供高质量的产品,我们将为用户提供注册防伪服务,凡是从官方渠道购买的产品,均可进行防伪查询

操作步骤如下:

1. 登录 angrymiao.com/verify/
2. 输入 SN 码
3. 点击查询

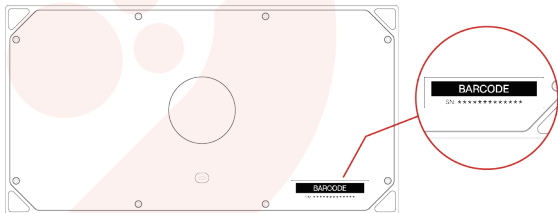

每个防伪码都是唯一的,且仅可以验证对应的一件商品

若您发现购买到的产品无法注册或者注册失败,请您仔细辨别该产品

10 售后服务

国内售后条款

关于退换货

1. 签收快递时请务必开箱验货，如发现物流外箱破损或产品外观明显瑕疵，请直接拒收；如发现缺少零件或配件，请保留开箱的照片或视频，在 24 小时内联系我们
2. 自签收快递之日起 7 日内（包含 7 日）可以申请退货（个人定制产品除外），第 8-15 日内（包含 15 日）仅可以申请换货，或者选择免费修理
3. 对于限量产品，同一（1）件售出的产品，只能进行一（1）次退货或换货，如没有库存进行更换，只能申请退货服务
4. 以下情况不在退换货服务内：
 - 超过了规定退换货时效
 - 非产品质量问题的人为损坏
 - 非怒喵官方或授权平台产生的交易，比如二手平台的转单
 - 产品内部异色、划痕、色差为正常现象，以及产品外观的细微痕迹（直径小于 0.3mm 的杂点或异色），气纹，色差等不影响使用的情况，均不在售后范围内
5. 因个人原因申请退货退款，运费将不予退还，且用户需承担产品退回的运费

国内售后条款

关于保修

当您购买的以下产品出现非人为损坏故障时，我们提供相应维修服务，请您提供相应购买凭证并在保修期限内联系我们！保修期限自快递签收之日起开始计算，对应产品保修期限如下：

客制化键盘属于高度自定义产品，我们提供1年保修服务，如涉及更换配件或耗材需要付费

以下情况不在保修范围内：

1. 无法提供相应的购买凭证
2. 已经超出保修期限
3. 意外因素或人为原因导致产品损坏，包括自行换 / 装轴导致轴变形、按键板脱焊等
4. 未经怒喵官方授权许可的自行改装、拆卸、维修等
5. 退换货、送修途中由于运输、装卸导致的产品损坏，包括产品遗失
6. 因不可抗因素（如雷电、地震、火灾等）造成的产品损坏

国内售后条款

售后服务指引

退换货或送修前，请核对以下内容是否准备齐全：

	主机、配件齐全	包装完整	发票(若有)	赠品(若有)
退货	√	√	√	√
换货	√	√		
维修	√			

1. 在免费保修期间的产品，在三包有效期内，消费者依照本规定享受修理、更换、退货的权利。如申请维修，更换下来的坏件归怒喵所有；对于检测无故障产品，将原样退回
2. 因产品不符合保修条件需收取费用的，将向消费者收取维修费，并提供维修报告



Index

01	Product Overview	33
02	Packaging Contents	37
03	Quick Start Guide	39
04	Shortcut Keys	41
05	Layout & DIY RGB	46
06	Build Guide	49
07	Leaf Spring Adjustment	51
08	Safety Information	53
09	Anti-Counterfeiting Notice	55
10	Aftersales Service	57

01 Product Overview

Product Overview

Product Name	CYBERBOARD
Weight	Base Kit 2.65kg (±0.1) / Bundle 2.9kg (±0.1)
Typing Angle	10°
LED Quantity	5*40 lamps, 200 LEDs, 81 in-switch LEDs
Mount	Three-stage adjustable leaf spring
Drivers	No additional drivers required, supports N-key rollover
Layout/Lighting Configuration	Configurable on Windows/macOS
Switch Mounting Style	Hot-swappable
Connectivity	Bluetooth (supports Windows 8.0+), USB Type-C (supports C to C)
Caps Lock Indicator	The indicator light is located between the numbers 6 and 7
USB Port	USB 2.0, Type-C, supports USB-C to USB-C
Battery	Lithium polymer 5000mAh *2, 10000mAh total (typical)
Qi Wireless Charging	Wireless charging 5W, starts charging automatically when battery power drops below 85% and stops at 100%
LED Colors	256 colors
Maximum Power Consumption	8W

Product Overview

Bundle

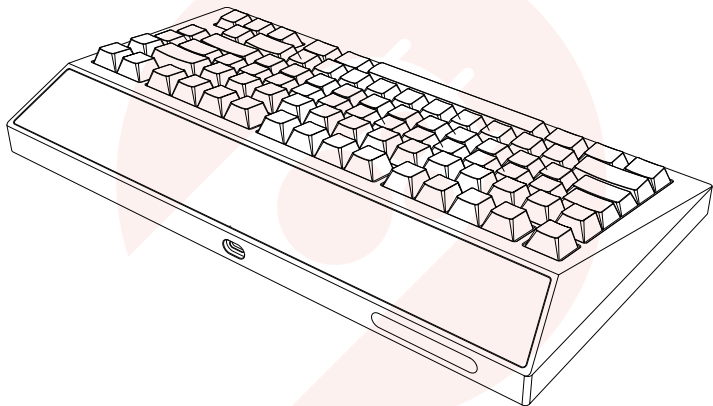

Product Overview

Base Kit

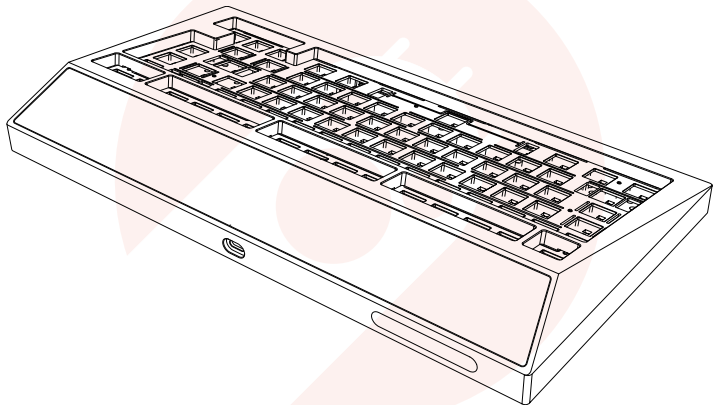

02 Packaging Contents

Packaging Contents

Base Kit includes:

Keyboard case (aluminium alloy), PCB (hotswap, cut-outs, RGB, 1.2mm thickness), POM plate (with cut-outs), Leaf Spring flex kit, carrying case.

Bundle includes:

Everything included in the Base Kit, and:

81 keycaps*, 81 Icy Silver Pro switches (linear), 4 Gateron INK Black stabilizers (screw-in, 2U*3, 6.25U*1).

*Cloud White V2 Bundle includes Angry Miao 021C keycaps, other Bundles include Glacier Dark keycaps.

03 Quick Start Guide

Quick Start Guide

1. Remove CYBERBOARD R4 from the packaging.
2. Upon first use, plug in the USB cable to activate the keyboard.
3. Turn on/off: long press Fn + Esc.
4. Bluetooth pairing: when not plugged in, long press Fn + 1 for 3s, until the animation on the LED panel indicates  , to enter Bluetooth pairing mode and connect to device.
5. Battery status: short press Fn + F12 to switch to the last LED panel effect, which indicates battery status.

04 Shortcut Keys

Shortcut Keys

1. Turn device on/off

Long press Fn + Esc for 3s

2. Factory reset

Long press Fn + R for 5s

3. Media combos

Fn + F1

Mute

Fn + F2

Volume down

Fn + F3

Volume up

Fn + F4

Previous track

Fn + F5

Next track

Fn + F6

Play/pause



Shortcut Keys

4. LED panel and in-switch lighting control combos

Fn + F9	Enable/disable in-switch LEDs
Fn + F10	Enable/disable LED panel
Fn+F11	Switch between in-switch lighting effects
Fn+F12	Switch between LED panel effects (the last effect is battery status)
Fn + ↑	Increase LED panel brightness
Fn + ↓	Decrease LED panel brightness
Fn + →	Increase LED panel effect speed
Fn + ←	Decrease LED panel effect speed
Fn + +/-	Decrease/increase in-switch LED brightness





Shortcut Keys

5. Bluetooth connection

Fn + 1	To connect to device 1 in Bluetooth mode, press and hold for 5s until the LED animation  starts flashing. The animation will stop flashing after successfully pairing, and the LED panel will resume its previous display.
Fn + 2	To connect to device 2 in Bluetooth mode, press and hold for 5s until the LED animation  starts flashing. The animation will stop flashing after successfully pairing, and the LED panel will resume its previous display.
Fn + 3	To connect to device 3 in Bluetooth mode, press and hold for 5s until the LED animation  starts flashing. The animation will stop flashing after successfully pairing, and the LED panel will resume its previous display.
Device switching	Press Fn + 1/2/3 to switch between different connected devices. The animation will display for 5s, and the LED panel will resume its previous display.
Bluetooth standby status	After 10 minutes of standby, the LED panel will turn off automatically while the keyboard keeps the connection. Press any key to wake up the keyboard. *The keyboard does not automatically enter standby under wired mode. However, after turning off the connected computer, the keyboard will automatically switch to Bluetooth mode and enter standby after 10 minutes.

Shortcut Keys

6. Battery status

Battery status	Short press Fn + F12 to switch to the last LED panel effect, which indicates battery status.	
Charging starts	When charging starts, the LED panel will display the charging animation for 3s and then return to its previous display.	
Charging status	Short press Fn + F12 to switch to the last LED panel effect, which indicates battery status. The blinking "+" icon indicates charging.	
Fully charged	The LED panel displays the following icon for 5s and then returns to its previous display.	
Battery low	When the battery level reaches below 5%, the LED panel will display a red battery icon until the battery is fully empty. You can press Fn + F10 to disable the screen.	

05 Layout & DIY RGB

Layout & DIY RGB

1. Download AM Master from angrymiao.com/am-master and keep the keyboard connected to the computer via USB.
 2. Enter diy.angrymiao.com and select the corresponding keyboard model in the top bar to edit function keys and lighting effects (navigate to the "In-Switch LED configuration" page through the link on the right bottom of the DIY page).
 3. After finishing editing, generate the JSON config file and download it.
 4. Open AM Master, select your JSON config file and import it (you can directly use config files shared by others).
 5. Wait until it's successfully configured.
- Layers: by default, you can switch to layer 2 by holding down the Fn key. You can also switch directly to corresponding layers by short pressing manually assigned layer keys. You can create a maximum of 7 layers.

CYBERBOARD Lighting DIY Tutorial

1. DIY site: diy.angrymiao.com.
2. Click on the link at the bottom of the page to view the DIY lighting effect tutorial.

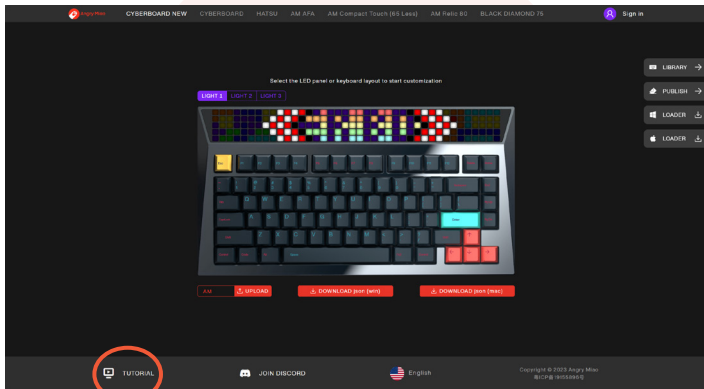

06 Build Guide

Build Guide

Caution: installing switches on the hot-swap PCB

Please remove PCB cable carefully according to the build guide. Take out the plate and install the switches without using excessive force.

During installation, ensure that the pins are not bent. If you're unable to insert your switch into the PCB, adjust the angle of the switch and ensure there's no defect in the pins. Do not use excessive force, as to avoid damaging the hot-swap sockets and PCB.

Scan the QR code below or open youtu.be/b1Zf1jki5A4 to watch the Build Guide. You can also search for "CYBERBOARD R4 - Build Guide" on YouTube.



07 Leaf Spring Adjustment

Leaf Spring Adjustment

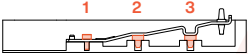
	Stainless Steel Leaf Spring (hard, default) Optional Phosphorus Copper Leaf Spring (soft)		
	Gear 1 - soft (no stopper)		
	Gear 2 - balanced (stopper in gear 2)	Default	
	Gear 3 - hard (stopper in gear 3)		
PCB pad	1 (removable, attached by default)		
Adjustment pads (with cut-outs)	None (soft)	1 (balanced, default)	2 (hard)
Bottom pad (without cut-outs)	1 (reduces hollow sound and protects PCB components; default)		

08 Safety Information

Warning

- Disassembling, hitting, squeezing and throwing into fire is prohibited.
- Stop using if severe swelling occurs.
- Do not place in high temperature environments.
- Do not use the battery after immersion in water.
- If the battery is replaced incorrectly, there is a risk of explosion. Repairs should only be performed by qualified service personnel. This is to ensure that product safety is maintained.

09 Anti-Counterfeiting Information

Anti-Counterfeiting Information

Anti-Counterfeiting Statement

In order to protect your rights and shopping experience, please verify the SN code as soon as the product arrives. Each SN code is unique and can only verify its corresponding item. If you cannot find the SN code, please carefully check the product.

Angry Miao is committed to providing users with high-quality products, which are equipped with anti-counterfeiting services. All products purchased from official channels can be checked for authenticity. To check product authenticity, follow these steps:

1. Log in to <https://verify.angrymiao.com>
2. Enter product's serial number
3. Click on the enquire button

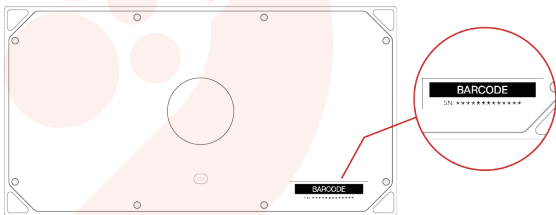

10 Aftersales Service

Aftersales Service

Return & Refund Policy

The following terms apply to regions outside of mainland of China.

Our policy lasts 72 hours for general items. If the time is due, unfortunately we can't offer you a refund or exchange.

There are certain situations we can't offer you a refund or exchange:

- 72 hours have gone by since you received the item.
- Any item not in its original condition, is damaged or missing parts for reasons not due to our error.
- Dislike due to personal preferences.

1. If you need to refund or exchange, please click Contact Us on the bottom of our website and leave your message. We will contact you within 3 working days.
2. To be eligible for a return, your item must be unused and in the same condition that you received it. It must also be in the original packaging. Any missing parts will delay the refund or cause partial refunds.
3. You will be refunded after we receive the returned product and check it. Once your return is received and inspected, we will send you an email to notify you that we have received your returned item. Then your refund will be processed, and a credit will automatically be applied to your credit card or original method of payment, within 7 business days.
4. If there is insufficient stock of exchanging products, we will inform you about the specific treatment.
5. Please contact us first if you want a refund or exchange. We will not accept returns or exchanges if you haven't contacted us in advance.
6. After-sales service: support@angrymiao.com

Aftersales Service

Disclaimer

1. For related products purchased through non-official channels, we do not provide corresponding after-sales service and do not bear the transaction risk arising therefrom.
2. All rights reserved by Angry Miao.

